

FM/LM Series

DIN W72 × H72, W144 × H72mm of Up / Down / Up • Down measure counter

■ Features

- Selectable Multi / Divide function
- Upgrade counting speed : 1cps, 5kcps
- Selectable voltage input (PNP) or no-voltage input (NPN)
- Memory protection for 10years (Using non-voltage semiconductor)
- Decimal point setting (Fixed decimal point of display)
- Wide range of power supply : 100-240VAC 50/60Hz
12-24VAC/DC (Option)
- Built-in Microprocessor



⚠ Please read "Caution for your safety" in operation manual before using.

■ Specifications

F 4 A M - 2P

F	W72 × H72mm
4	9999 (Digit)
A	Preset
M	Measure function
2P	Dual preset
	Single preset
	6
	999999 (Digit)
	W144 × H72mm
	L
	W72 × H72mm
	F
	4
	9999 (Digit)
	6
	999999 (Digit)
	L
	W144 × H72mm
	F
	W72 × H72mm

■ Specifications

Model	Single preset	F4AM	F6AM	—	—	
	Dual preset	F4AM-2P	F6AM-2P	L4AM-2P	L6AM-2P	
	Totalizer (Indicator)	F4B	F6B	L4B	L6B	
Digit		4	6	4	6	
Digit size		W8 × H14mm	W4 × H8mm	W8 × H14mm		
Power supply		100-240VAC 50/60Hz, 12-24VAC/DC (Option)				
Allowable voltage range		90 ~ 110% of rated voltage				
Power consumption		<ul style="list-style-type: none"> • Indicator: Approx. 4.7VA (240VAC 60Hz), Approx. 5.1VA (24VAC 60Hz), Approx. 2.7W (24VDC) • Single preset: Approx. 5.6VA (240VAC 60Hz), Approx. 6.0VA (24VAC 60Hz), Approx. 3.3W (24VDC) • Dual preset: Approx. 6.5VA (240VAC 60Hz), Approx. 6.5VA (24VAC 60Hz), Approx. 3.8W (24VDC) 				
Max. counting speed		Selectable 1cps/30cps/2kcps/5kcps by internal DIP switch				
Min. signal width		Approx. 20ms (Reset input)				
Input type	CP1, CP2 input	[Voltage input] Input impedance : 5.4kΩ, "H" level voltage : 5-30VDC, "L" level voltage : 0-2VDC				
	RESET input	[No-Voltage input] Impedance at short-circuit : Max. 1kΩ, Residual voltage at short-circuit : Max. 2VDC, Impedance at open-circuit : Max. 100kΩ				
One-shot output time		Single preset : 0.5sec, Dual preset : 0.05~5sec				
Control output	Con-tact	Type	Single preset : SPDT (1c) Dual preset : Single preset SPST (1a), Dual preset SPST (1a)	Dual preset : Single preset SPDT (1c), Dual preset SPDT (1c)		
		Capacity	250VAC 3A resistive load			
	Solid-state	Type	Single preset : 1 NPN open collector output, Dual preset : 2 NPN open collector output			
		Capacity	30VDC Max. 100mA Max.			
Memory protection		10 years (When using non-volatile semiconductor memory)				
External power		12VDC ± 10% 50mA Max.				

Up/Down/Up • Down Measure Counter

Specifications

Insulation resistance		35 ~ 85%RH
Dielectric strength		100MΩ (at 500VDC mega)
Noise strength	AC power	±2kV the square wave noise (pulse width:1μs) by the noise simulator
	DC power	±500V the square wave noise (pulse width:1μs) by the noise simulator
Vibration	Mechanical	0.75mm amplitude at frequency of 10 ~ 55Hz in each of X, Y, Z directions for 1 hour
	Malfunction	0.5mm amplitude at frequency of 10 ~ 55Hz in each of X, Y, Z directions for 10 minutes
Shock	Mechanical	300m/s ² (Approx. 30G) in X, Y, Z directions 3 times
	Malfunction	100m/s ² (Approx. 10G) in X, Y, Z directions 3 times
Relay life cycle	Mechanical	Min. 10,000,000 times
	Electrical	Min. 100,000 times (250VAC 3A at resistive load)
Ambient temperature		-10 ~ +55°C (at non-freezing status)
Storage temperature		-25 ~ +65°C (at non-freezing status)
Ambient humidity		35 ~ 85%RH
Unit weight	AC power	F4AM:Approx. 273g, F6AM:Approx. 280g, F4AM-2P:Approx. 275g, F6AM-2P:Approx. 282g, F4BM:Approx. 229g, F6BM:Approx. 236g, L4AM:Approx. 505g, L6AM-2P:Approx. 533g, L4AM-2P:Approx. 438g, L6BM:Approx. 445g
	DC power	F4AM:Approx. 268g, F6AM:Approx. 275g, F4AM-2P:Approx. 270g, F6AM-2P:Approx. 287g, F4BM:Approx. 224g, F6BM:Approx. 231g, L4AM-2P:Approx. 511g, L6AM-2P:Approx. 538g, L4BM-2P:Approx. 444g, L6BM:Approx. 450g

Connections

●F4AM-2P / F6AM-2P

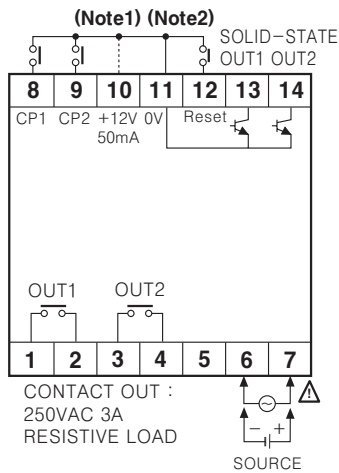

●F4AM / F6AM

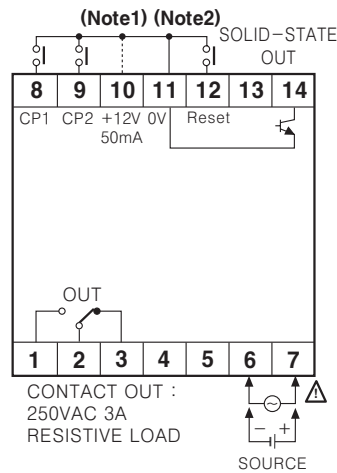

●F4BM / F6BM

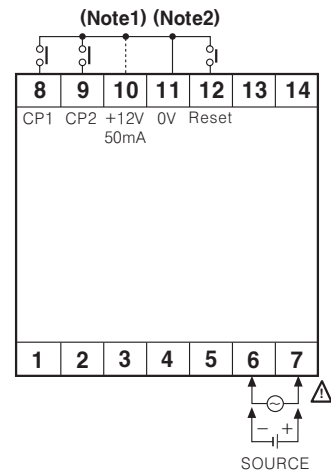

●L4AM-2P / L6AM-2P

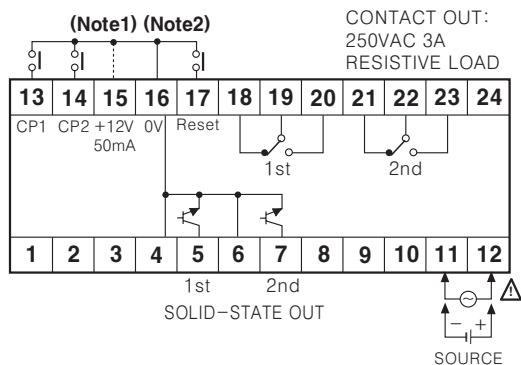

●L4BM / L6BM

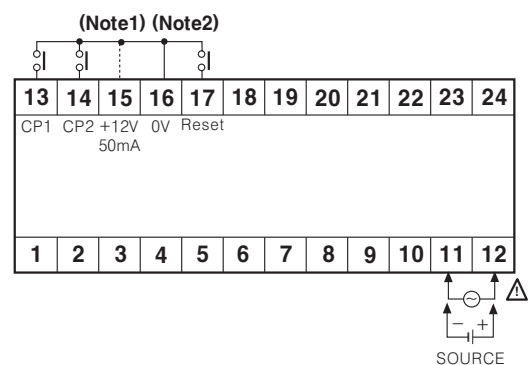

- ※ (Note1) : Connection for PNP input in contact input
- ※ (Note2) : Connection for NPN input in contact input

(A) Counter

(B) Timer

(C) Temp. controller

(D) Power controller

(E) Panel meter

(F) Tacho/Speed/Pulse meter

(G) Display unit

(H) Sensor controller

(I) Switching power supply

(J) Proximity sensor

(K) Photo electric sensor

(L) Pressure sensor

(M) Rotary encoder

(N) Stepping motor & Driver & Controller

(O) Graphic panel

(P) Production stoppage models & replacement

FM/LM Series

Dimensions

FM-Series

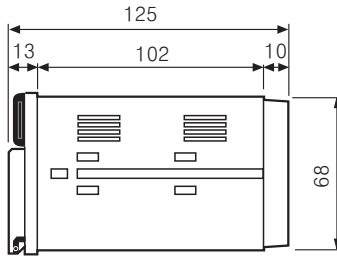
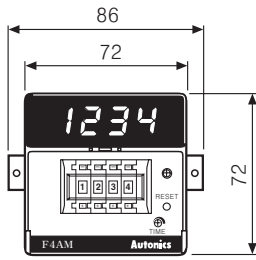

Panel cut-out

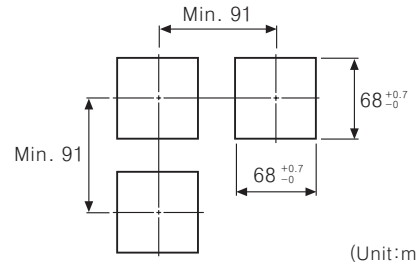

(Unit:mm)

LM-Series

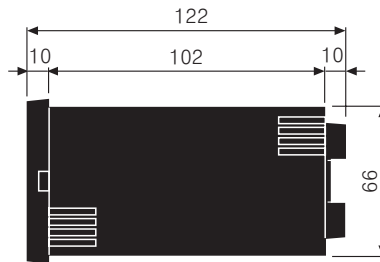
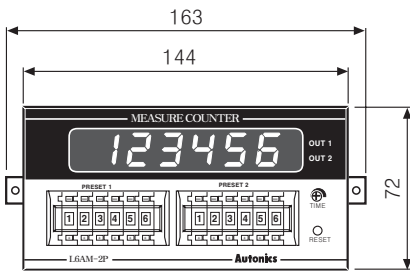

Panel cut-out

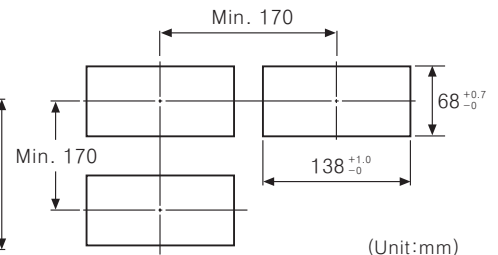

(Unit:mm)

Input connections

⊙No-voltage input (NPN)

- Solid-state input (Standard input sensor : NPN output type sensor)

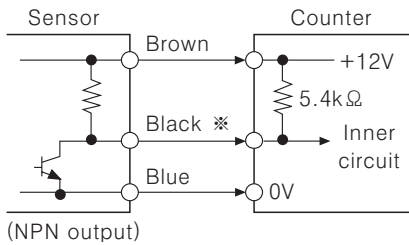

(NPN output)

※CP1, CP2, RESET input

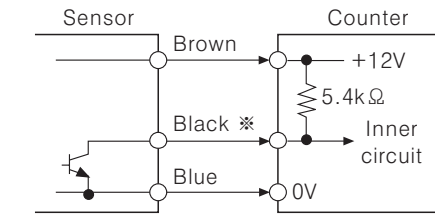

(NPN open collector output)

- Contact input

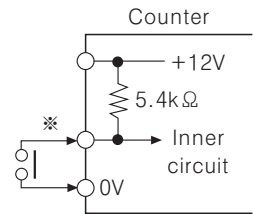

Counting speed :
Set as 1 or 30cps

⊙Voltage input (PNP)

- Solid-state input (Standard input sensor : PNP output type sensor)

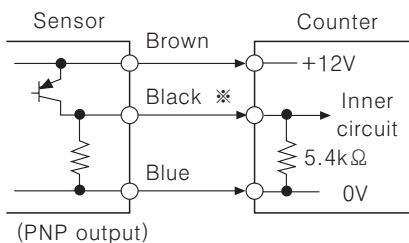

(PNP output)

※CP1, CP2, RESET input

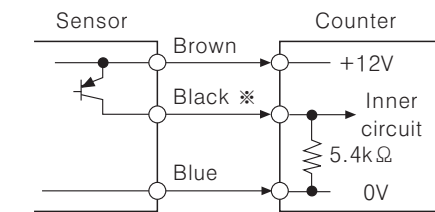

(PNP open collector output)

- Contact input

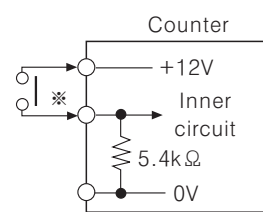

Counting speed :
Set as 1 or 30cps

Up/Down/Up • Down Measure Counter

Input logic selection

FM Series

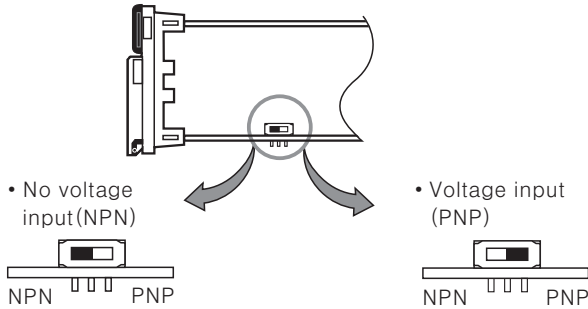

※ Please be sure to turn OFF the power before changing input logic.

LM Series

Input logic is changeable by input logic selection switch located at the terminal block.

- No voltage input (NPN)
 - Voltage input (PNP)
- (NPN) F S (PNP) (NPN) F S (PNP)

Input & output connections

⊙ In case of operating the load by power supply of the sensor

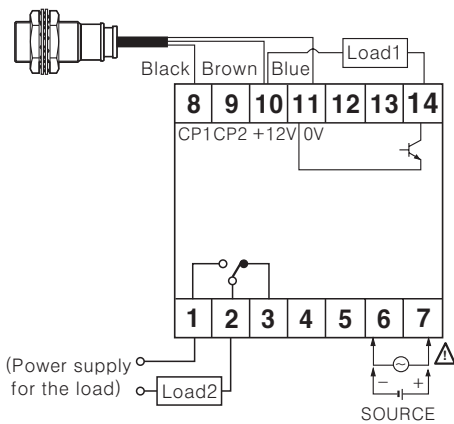

- Please select proper capacity of load, because total value of load capacity and current consumption should not exceed current capacity (Max. 50mA).

⊙ In case of operating the load by external power supply

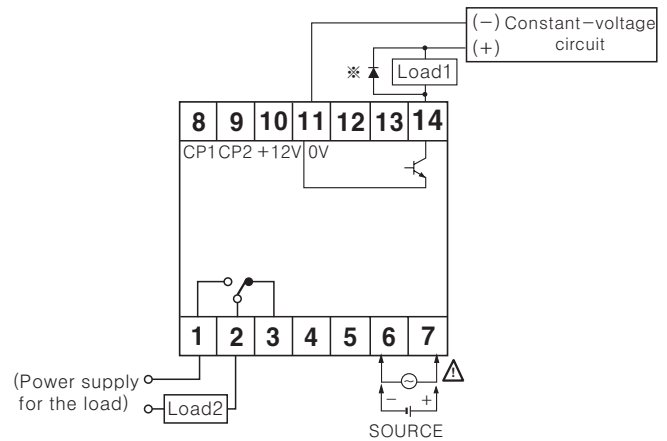

- The capacity of the load must not exceed Max. 30VDC, Max. 100mA of the switching capacity of the transistor.
- Please do not supply the reverse polarity voltage.
- ※ In case of using the inductive load (Relay, etc.), please connect the surge absorber (Diode) at both terminals of the load, in case of using the inductive load.

⊙ How to count by external power supply

This unit start to count when "High" level (5–30VDC) is applied at CP1 or CP2 after selecting PNP. ("Low level" : 0–2VDC)

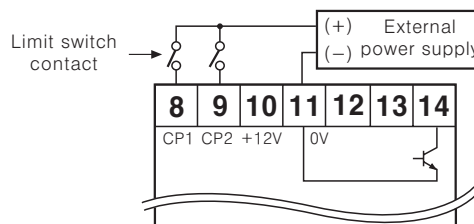

⊙ Using 2 counters with one sensor

- Please connect as the power of sensor is supplied from only one of counters and design input logic with same way.

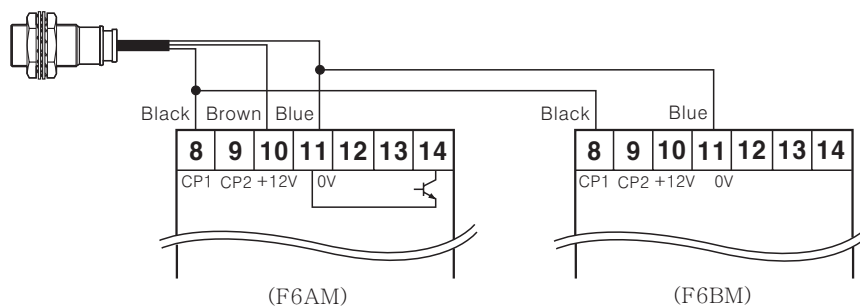

(A) Counter

(B) Timer

(C) Temp. controller

(D) Power controller

(E) Panel meter

(F) Tacho/Speed/Pulse meter

(G) Display unit

(H) Sensor controller

(I) Switching power supply

(J) Proximity sensor

(K) Photo electric sensor

(L) Pressure sensor

(M) Rotary encoder

(N) Stepping motor & Driver & Controller

(O) Graphic panel

(P) Production stoppage models & replacement

FM/LM Series

■ Selection by DIP switches

● FM Series

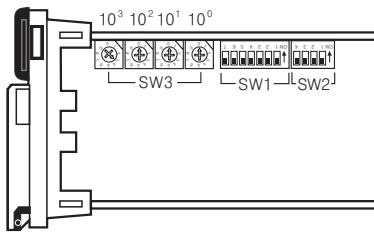

● LM Series

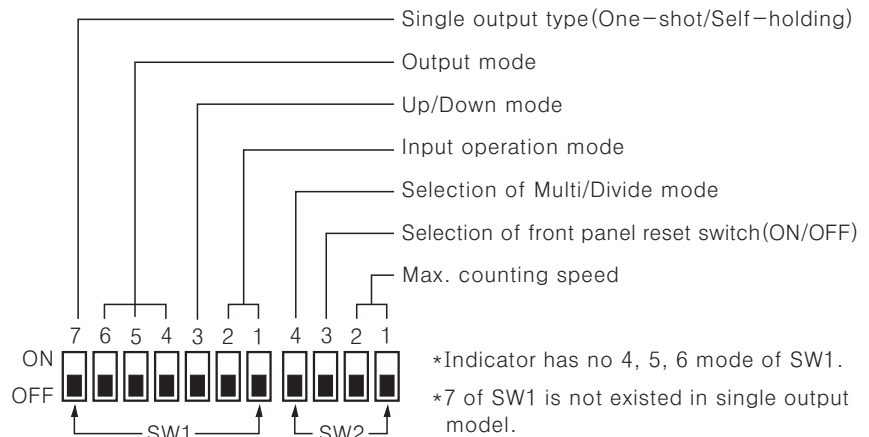
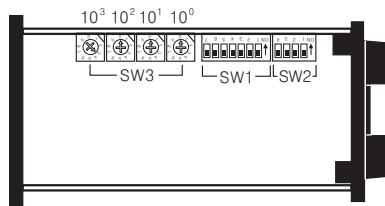

● Max. counting speed

SW2	Function
1 2 ON OFF <input type="checkbox"/> <input type="checkbox"/>	1cps
1 2 ON OFF <input type="checkbox"/> <input checked="" type="checkbox"/>	30cps
1 2 ON OFF <input checked="" type="checkbox"/> <input type="checkbox"/>	2kcps
1 2 ON OFF <input checked="" type="checkbox"/> <input checked="" type="checkbox"/>	5kcps

*Factory default : 30cps

● Reset switch of front panel

SW2	Function
3 ON OFF <input type="checkbox"/> <input type="checkbox"/>	Use
3 ON OFF <input checked="" type="checkbox"/> <input type="checkbox"/>	Not used

*Factory default : Not used

● Measure function

SW2	Function
4 ON OFF <input type="checkbox"/> <input type="checkbox"/>	Multi mode
4 ON OFF <input checked="" type="checkbox"/> <input type="checkbox"/>	Divide mode

*See A-70 for "Measure Counter".

*Factory default : Divide mode (SW3:0001)

● Up/Down mode selection

SW1	Function
3 ON OFF <input type="checkbox"/> <input type="checkbox"/>	Up mode
3 ON OFF <input checked="" type="checkbox"/> <input type="checkbox"/>	Down mode

*Factory default : Up mode

● Single output type

SW1	Function
7 ON OFF <input type="checkbox"/> <input type="checkbox"/>	One-shot output
7 ON OFF <input checked="" type="checkbox"/> <input type="checkbox"/>	Retained output

*Default : Retained output

*This mode selects one-shot output (0.5sec) or remained output (until 2nd output turns off) for 1st output in the dual preset counter.

*Example of F output operation mode

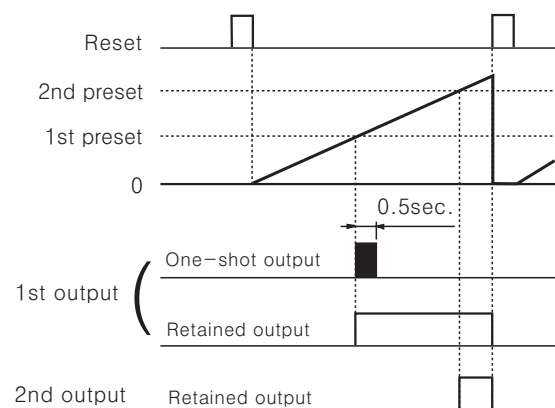

Up/Down/Up • Down Measure Counter

Measure Counter

Measure counter sets multiply or divide integer per 1 pulse input.

SW2	Function
4 ON	Multi
4 OFF	

Multi Mode

It multiplies the inner SW3 setting value at a count input signal and displays it.

Input signal(N) × SW3 preset value = Indication value

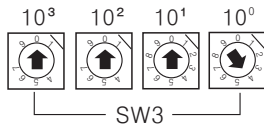

$$\therefore N \times 4 = 4, 8, 12 \dots (N=1, 2, 3 \dots)$$

SW2	Function
4 ON	Divide
4 OFF	

Divide Mode

It displays as 1 when the count input signal is entered as preset value of inner SW3.

$$\frac{\text{Input signal(N)}}{\text{SW3 preset value}} = \text{Indication value}$$

$$\therefore \frac{N}{5} = 1, 2, 3 \dots (N=5, 10, 15 \dots)$$

(Note) Please be cautious the error can be occurred when down count is executed during up count.

Decimal point setting

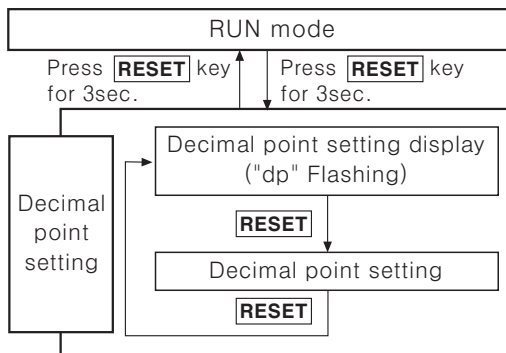

※ It advances to "Decimal point setting mode" if press RESET key for 3sec.

※ It returns to RUN mode by press RESET key for 3sec in "Decimal point setting mode".

※ It returns to RUN mode if no RESET button or digital switch (Dual-setting digital switch for dual preset type) is applied for 60sec. in the "Decimal point setting mode".

※ The decimal point setting is not existed in indicator.

Decimal point setting

- The decimal point setting of 6digits indicator

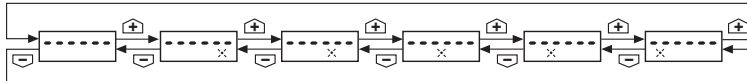

- The decimal point setting of 4digits indicator

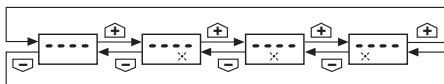

※ When it enters to the "Decimal point of setting mode, the prior decimal setting status is displayed.

※ In the decimal point setting mode, when pressing one of the Up (⬆) button of digital switch (Dual-setting digital switch for dual preset type), the point is moved to left direction and it is moved to right direction when one of Down (⬇) button of digital switch (Dual-setting digital switch for dual preset type).

Counting function(Indication type)

Up mode

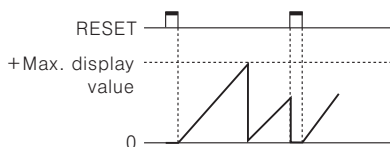

Down mode

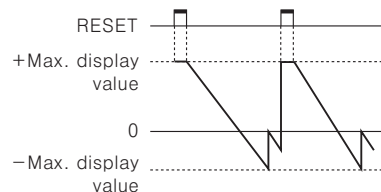

Up / Down-A, B, C mode

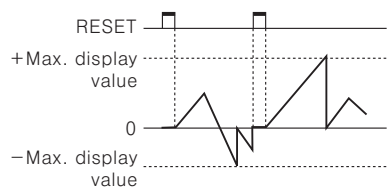

Up / Down-D, E, F mode

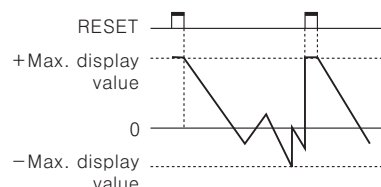

FM/LM Series

Input operation mode

Input mode(SW1)		SW1	No-voltage input type(NPN)	Voltage input type(PNP)
Up mode	Up/Down-A (Command input)	ON  OFF 		
	Up/Down-B (Individual input)	ON  OFF 		
	Up/Down-C (Phase difference input)	ON  OFF 		
	Up (Count up input)	ON  OFF 		
Down mode	Up/Down-D (Command input)	ON  OFF 		
	Up/Down-E (Individual input)	ON  OFF 		
	Up/Down-F (Phase difference input)	ON  OFF 		
	Down (Count down input)	ON  OFF 		

* Ⓐ: Over Min. signal width, Ⓑ: Over 1/2 of Min. signal width.

If the signal width of Ⓐ or Ⓑ is less than Min. signal width, ±1 of count error is occurred.

Up/Down/Up • Down Measure Counter

Output operation mode

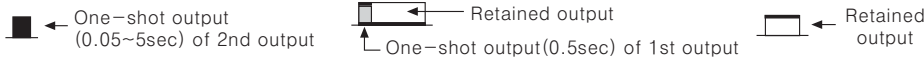

*The output of single preset type is operated at the status of the second output mode

Output mode (SW1)	ON OFF	Up mode	Down mode	Operation after count up
	ON OFF	Up, Up/Down-A, B, C mode	Down, Up/Down-D, E, F mode	
F	ON OFF			The display value continues until Reset signal applied and the output is held. • 1st retained output and 2nd output are maintained until Reset signal is applied. • When using 1st output as one-shot output, it will return after operating for 0.5sec.
N	ON OFF			Display value and retained output are maintained until Reset signal is applied. • When using 1st output as one-shot output, it will return after operating for 0.5sec.
C	ON OFF			The display value will be Reset Start status as soon as it reaches to 2nd setting value. • 1st retained output will be OFF after 2nd one-shot output. • 1st one-shot output will be reset after operating 0.5sec., and it is not related to 2nd output.
R	ON OFF			The display value will be held until 2nd output is OFF then reset. • 1st retained output will be OFF after 2nd one-shot output. • 1st one-shot output will be reset after operating 0.5sec., and it is not related to 2nd output.
K	ON OFF			The display value continues until Reset signal applied. • 1st retained output will be OFF after 2nd one-shot output. • 1st one-shot output will be reset after operating 0.5sec., and it is not related to 2nd output.
P	ON OFF			The display value will be Reset Start status as soon as it reaches to 2nd setting value. • 1st retained output will be OFF after 2nd one-shot output. • 1st one-shot output will be reset after operating 0.5sec., and it is not related to 2nd output.
Q	ON OFF			The display continues until 2nd output is OFF. • 1st retained output will be OFF after 2nd one-shot output. • 1st one-shot output will be reset after operating 0.5sec. not related to 2nd output.
S	ON OFF	Up input	Down input	• Up, Up/Down-A, B, C input mode -OUT1 is ON when (Display value) \geq (1st setting value) -OUT2 is ON when (Display value) \geq (Dual setting value) • Down, Up/Down-D, E, F input mode -OUT1 is ON when (Display value) \leq (1st setting value) -OUT2 is ON when (Display value) \leq (Zero)
		Up/Down-A, B, C	Up/Down-D, E, F	

*One-shot output time is set by front TIME adjuster.

(A) Counter

(B) Timer

(C) Temp. controller

(D) Power controller

(E) Panel meter

(F) Tacho/Speed/Pulse meter

(G) Display unit

(H) Sensor controller

(I) Switching power supply

(J) Proximity sensor

(K) Photo electric sensor

(L) Pressure sensor

(M) Rotary encoder

(N) Stepping motor & Driver & Controller

(O) Graphic panel

(P) Production stoppage models & replacement

FM/LM Series

■ Proper usage

○ Reset function

● Reset

In case of changing the input mode after supplying the power, please take an external reset or manual reset. **If reset is not executed, the counter will be working as previous mode.**

● Reset signal width

It is reset perfectly when the reset signal is applied during **max. 20ms** regardless of the contact input & solid-state input.

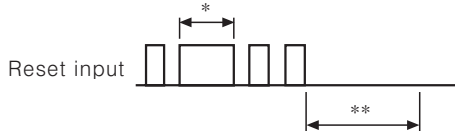

*In case of a contact reset, it is reset perfectly if the ON time of reset signal is applied during max. 20ms even though a chattering is occurred.

**It can be input the signal of CP1 & CP2 after max. 50ms from closing time of reset signal.

○ Min. signal width

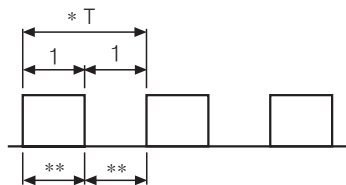

*Please make duty ratio(ON/OFF) 1:1.

** Min. signal width

- 1cps : Min. 500ms
- 30cps : Min. 16.7ms
- 2kcps : Min. 0.25ms
- 5kcps : Min. 0.1ms

○ Max. counting speed

This is a response speed per 1 sec. when the duty ratio (ON:OFF) of input signal is 1:1. If the duty ratio is not 1:1, the width between ON and OFF should be over min. signal width and the response speed is getting slower against input signal.

If either ON or OFF signal is shorter than minimum signal width, this product may not respond.

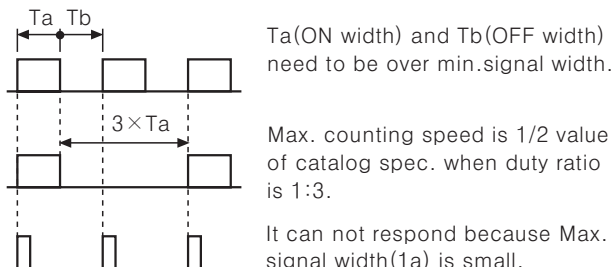

○ Error display

Error signal	Error description	Returning method
Err0	Zero setting status	Change the setting value to non zero status

※When Error is displayed, the output continues OFF state.
 ※1st output maintains OFF status by set 1st setting value as 0.
 ※There is no Error function indicator.

○ Detach the case from body

● FM Series

Unscrew the front bolt, and pull the body forward.

● LM Series

Unscrew the rear bolt, and pull the body forward.

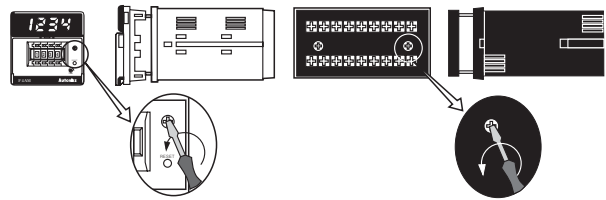

○ Power

●The inner circuit voltage starts to rise up for the first 100ms after power on, the input may not work at this time. And also the inner circuit voltage drops down for the last 500ms after power off, the input may not work at this time.

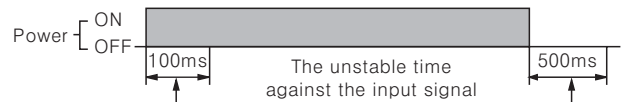

●Please use the power within rated power and apply or cut the power at once to prevent from chattering.



○ Input signal line

- Shorten the cable distance between the sensor and this product.
- Please use shield wire for input signal needed to be long.
- Please wire input signal line separated from power line.

○ Test circuit dielectric, impulse voltage and measure insulated resistor by installing in control panel,

- Separate the unit from control box circuit.
- Short-circuit all terminals in terminal block.

○ Do not use this unit at below places.

- Place where there are severe vibration or impact.
- Place where strong alkalis or acids are used.
- Place where there are direct rays of the sun
- Place where strong magnetic field or electric noise are generated.

○ Installation environment

- It shall be used indoor
- Altitude Max. 2000m
- Pollution Degree 2
- Installation Category II.