

AT8SDN Series

DIN W48×H48mm Star-Delta timer

■ Features

- Realization of wide range of power supply
: 100-240VAC 50/60Hz / 24-240VDC universal
- Wide range of setting time and switching time
 - T1(Setting time) : Selectable 0.5 to 100sec.
 - T2(Switching time) : Selectable 0.05, 0.1, 0.2, 0.3, 0.4, 0.5sec.
- Simple setting time, switching time operation
- Easy to check output status by LED display
- Application : Starting large capacity motors



⚠ Please read "Caution for your safety" in operation manual before using.



■ Ordering information

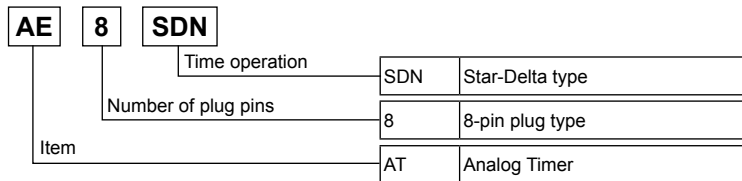

※Sockets (PG-08, PS-08, PS-M8) are sold separately.

■ Specifications

Model		AT8SDN
Function		Star-Delta timer
Control time setting range		0.5 to 100 sec.
Power supply		100-240VAC 50/60Hz / 24-240VDC universal
Allowable voltage range		90 to 110% of rated voltage
Power consumption		100-240VAC : 3.2VA, 24-240VDC : 1.5W
Reset time		Max. 100ms
Timing operation		Power ON start type
Control output	Contact type	λ contact : SPST(1a), Δ contact : SPST(1a)
	Contact capacity	250VAC 5A resistive load
Relay life cycle	Mechanical	Min. 10,000,000 operations
	Electrical	Min. 100,000 operations(250VAC 5A resistive load)
Repeat error		Max. $\pm 0.2\%$ ± 10 ms
λ Setting error		Max. $\pm 5\%$ ± 50 ms
Voltage error		Max. $\pm 0.5\%$
Temperature error		Max. $\pm 2\%$
λ - Δ Switching time error		Max. $\pm 25\%$
Insulation resistance		100M Ω (at 500VDC megger)
Dielectric strength		2000VAC 50/60Hz for 1 minute
Noise strength		± 2 kV the square wave noise(pulse width : 1 μ s) by the noise simulator
Vibration	Mechanical	0.75mm amplitude at frequency of 10 to 55Hz(for 1 min.) in each of X, Y, Z directions for 1 hours
	Malfunction	0.5mm amplitude at frequency of 10 to 55Hz (for 1 min.) in each of X, Y, Z directions for 10 minutes
Shock	Mechanical	300m/s ² (approx. 30G) in each of X, Y, Z directions for 3 times
	Malfunction	100m/s ² (approx. 10G) in each of X, Y, Z directions for 3 times
Environment	Ambient temperature	-10 to 55°C, storage: -25 to 65°C
	Ambient humidity	35 to 85%RH, storage: 35 to 85%RH
Approval		CE c UL US
Accessory		Bracket
Unit weight		Approx. 90g

※Environment resistance is rated at no freezing or condensation.

Small Star-Delta Timer

■ Connections

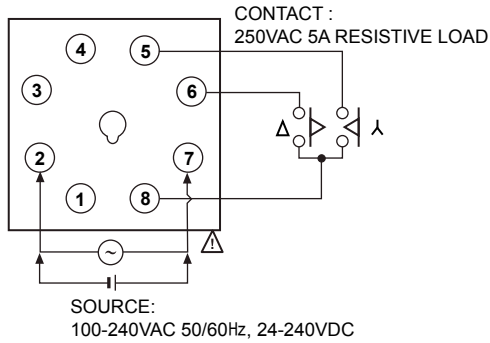

■ Dimensions

(unit: mm)

● Bracket

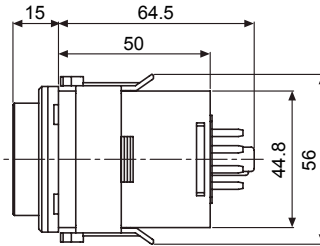
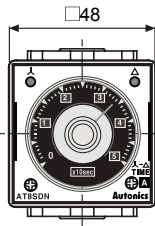
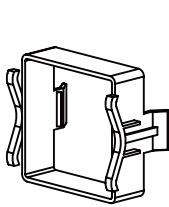

● Panel cut-out

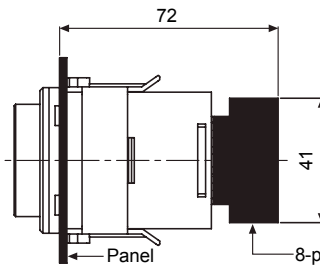
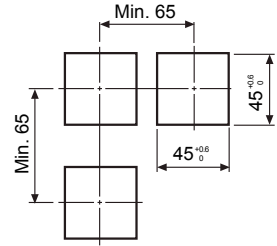

8-pin socket : PG-08(sold separately)
※ Refer to the G-15 page.

■ Parts description

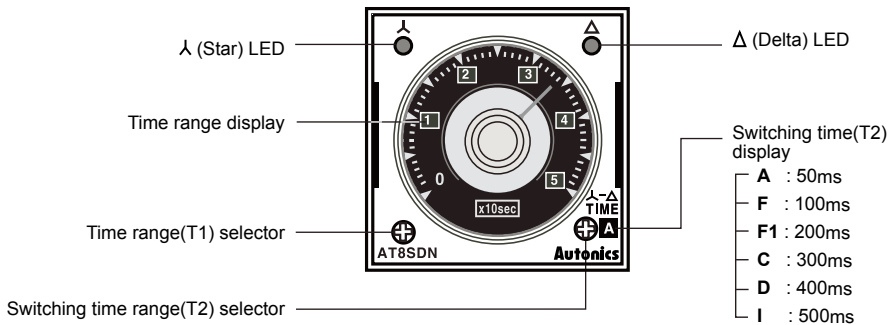

(A)	Photo electric sensor
(B)	Fiber optic sensor
(C)	Door/Area sensor
(D)	Proximity sensor
(E)	Pressure sensor
(F)	Rotary encoder
(G)	Connector/ Socket
(H)	Temp. controller
(I)	SSR/ Power controller
(J)	Counter
(K)	Timer
(L)	Panel meter
(M)	Tacho/ Speed/ Pulse meter
(N)	Display unit
(O)	Sensor controller
(P)	Switching mode power supply
(Q)	Stepper motor& Driver&Controller
(R)	Graphic/ Logic panel
(S)	Field network device
(T)	Software
(U)	Other

AT8SDN Series

Time specifications

1. T1(Setting time)

Time range	Time unit	Time setting range
0.5	×10sec	0.5 to 5sec.
1.0		1 to 10sec.
5		5 to 50sec.
10		10 to 100sec.

2. T2(λ - Δ Switching time)

(unit: sec)

Display	A	F	F1	C	D	I
T2 (λ-Δ Switching time)	0.05	0.1	0.2	0.3	0.4	0.5

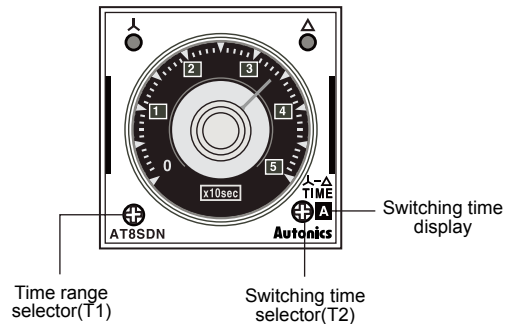

Output operation mode

λ contact will be ON as soon as power is supplied, λ contact will be OFF when T1 setting time is up then Δ contact will be ON after T2 switching time is up. Δ contact will be OFF when cut off the power at the status of Δ contact is ON.

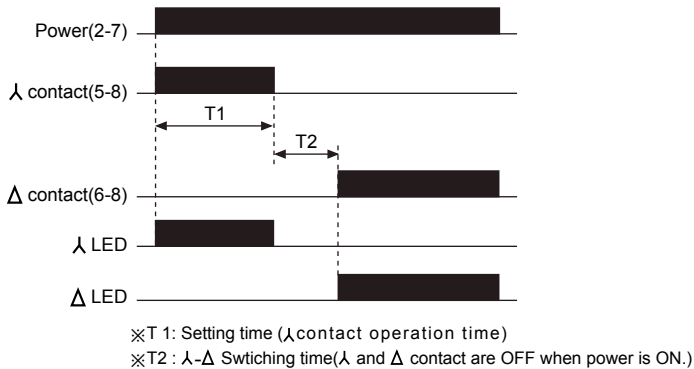

Proper usage

- Please supply power quickly at once with using switch or relay contact. Otherwise it may cause time error or power reset failure.
- When supply the power to the timer, connection shown in (Fig. 1) might cause malfunction due to leakage current through R and C. Please connect R and C as shown in (Fig.2) to prevent malfunction.

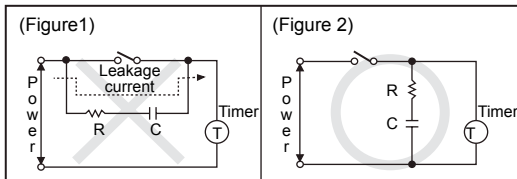

- When performing dielectric voltage test or insulation resistance test while the unit is installed on control panel,
- Please isolate this unit from the circuit of control panel.
- Please make all terminals of this unit short- circuited.
- Do not use this unit at below places.
- Place where there are severe vibration or impact.
- Place where strong alkalis or acids are used.
- Place where there are direct rays of the sun
- Place where strong magnetic field or electric noise are generated.
- Installation environment
- It shall be used indoor
- Altitude Max. 2000m
- Pollution Degree 2
- Installation Category II

- Change the setting time (T1), time range or λ -Δ switching time(T2). Otherwise, it might cause malfunction if changing the setting time (T1), time range or λ-Δ switching time(T2) during operation.