

ATE Series

DIN W48 × H48mm Solid State ON Delay Timer

■ Features

- DIN W48 × H48mm
- Easy and simple time setting
- Cost-effective
- Easy time setting
- Wide range of time
- Power supply
 - ATE : 110/220VAC 50/60Hz
 - ATE1, ATE2 : 110VAC, 220VAC 50/60Hz, 12VDC, 24VDC (Option)



⚠ Please read "Caution for your safety" in operation manual before using.

■ Ordering information

ATE		10	S	
				s
				m
				h
				Number
				Max. time range
				1
				2
				ATE

sec(1, 3, 6, 10, 30, 60)
min(3, 6, 10, 30, 60)
hour(3, 6, 12, 24)
Max. time range
Time-limit SPDT(1c), Instantaneous SPST(1a)
Time-limit DPDT(2c)
Time-limit SPDT(1c), Instantaneous SPDT(1c)
ON Delay Timer

■ Specifications

Model		ATE- s m h	ATE1- s m h	ATE2- s m h
Function		Power ON Delay		
Control time setting range		sec (1, 3, 6, 10, 30, 60), min (3, 6, 10, 30, 60), hour (3, 6, 12, 24)		
Power supply		110/220VAC 50/60Hz	110VAC, 220VAC 50/60Hz, 12VDC, 24VDC (Option)	
Allowable voltage range		90 ~ 110% of rated voltage		
Power consumption		Approx. 10VA (240VAC 60Hz), Approx. 2W (24VDC, 12VDC)		
Reset time		Max. 200ms		
Timing operation		Power ON Start type		
Control output	Contact type	Time limit SPDT(1c), Instantaneous SPST(1a)	Time limit DPDT(2c)	Time limit SPDT(1c), Instantaneous SPDT(1c)
	Contact capacity	250VAC 3A resistive load		
Relay life cycle	Mechanical	Min. 10,000,000 times		
	Electrical	Min. 100,000 times (250VAC 3A resistive load)		
Repeat error		Max. ±0.3%		
SET error		Max. ±5% ±0.05sec		
Voltage error		Max. ±0.5%		
Temperature error		Max. ±2%		
Insulation resistance		100MΩ (at 500VDC mega)		
Dielectric strength		2000VAC 50/60Hz for 1 minute		
Noise strength		±2kV the square wave noise (pulse width: 1μs) by the noise simulator		
Vibration	Mechanical	0.75mm amplitude at frequency of 10 ~ 55Hz in each of X, Y, Z directions for 1 hours		
	Malfunction	0.5mm amplitude at frequency of 10 ~ 55Hz in each of X, Y, Z directions for 10 minutes		
Shock	Mechanical	300m/s ² (Approx. 30G) in X, Y, Z directions 3 times		
	Malfunction	100m/s ² (Approx. 10G) in X, Y, Z directions 3 times		
Ambient temperature		-10 ~ 55°C (at non-freezing status)		
Storage temperature		-25 ~ 65°C (at non-freezing status)		
Ambient humidity		35 ~ 85%RH		
Unit weight		Approx. 75g		

Single Time Range Timer

Front panel identification

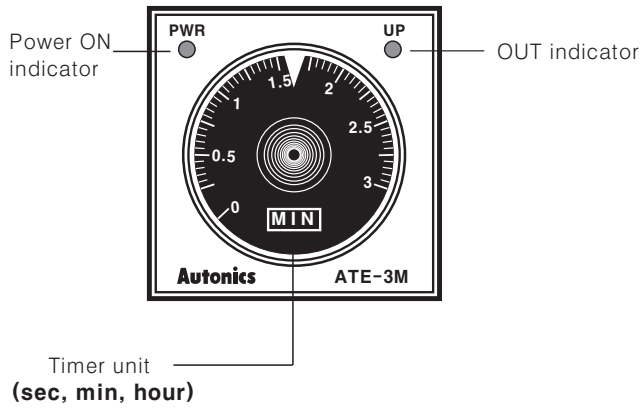

Time setting range

Max. setting time	Setting range
1sec	0~1sec
3sec	0~3sec
6sec	0~6sec
10sec	0~10sec
30sec	0~30sec
60sec	0~60sec
3min	0~3min
6min	0~6min
10min	0~10min
30min	0~30min
60min	0~60min
3hour	0~3hour
6hour	0~6hour
12hour	0~12hour
24hour	0~24hour

Operation mode

t : Setting time, Rt : Reset time

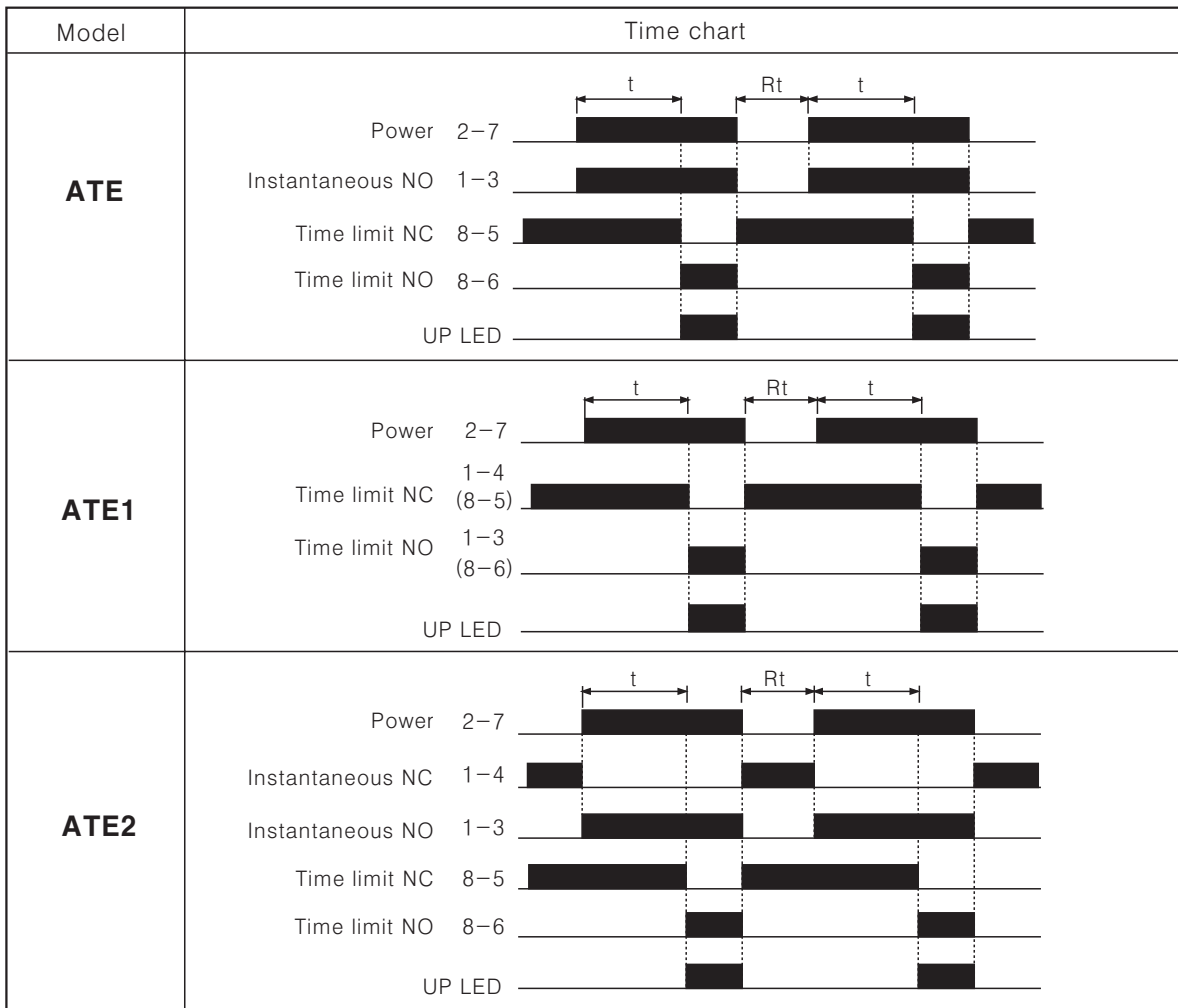

(A) Counter

(B) Timer

(C) Temp. controller

(D) Power controller

(E) Panel meter

(F) Tacho/Speed/Pulse meter

(G) Display unit

(H) Sensor controller

(I) Switching power supply

(J) Proximity sensor

(K) Photo electric sensor

(L) Pressure sensor

(M) Rotary encoder

(N) Stepping motor & Driver & Controller

(O) Graphic panel

(P) Production stoppage models & replacement

ATE Series

Connections

ATE Series

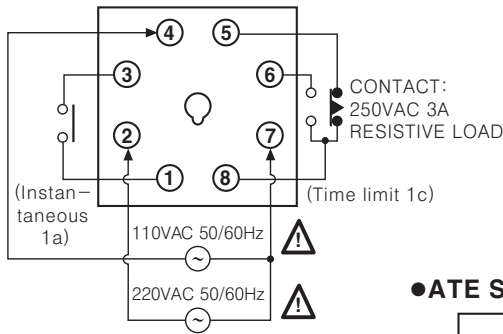

ATE1 Series

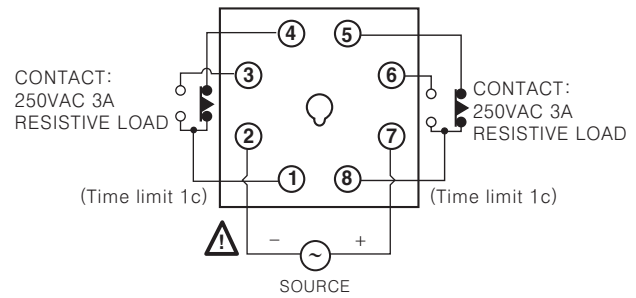

ATE Series

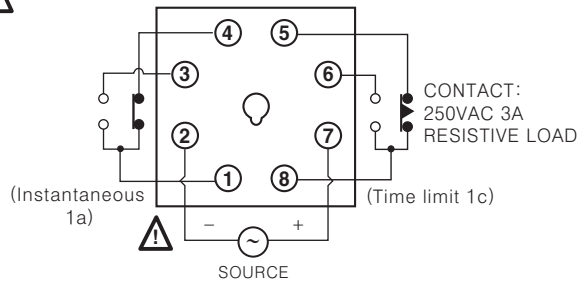

Dimensions

Bracket (Sold separately)

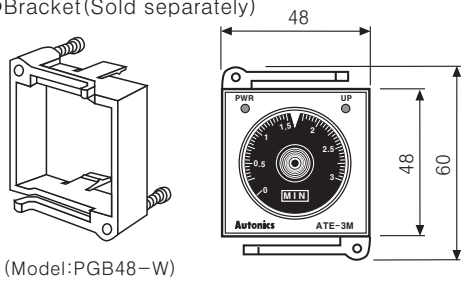

(Model: PGB48-W)

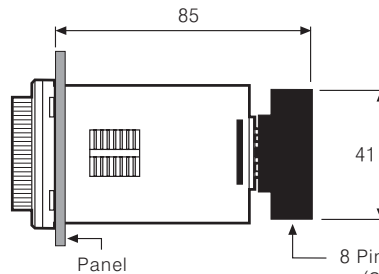
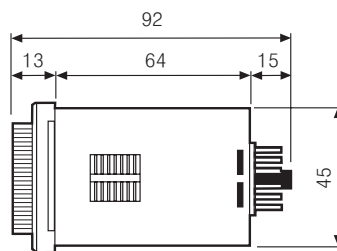

Panel cut-out

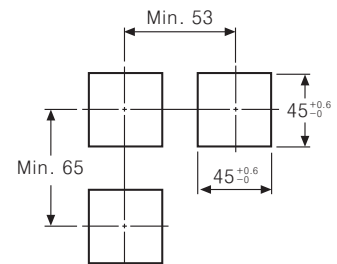

(Unit:mm)

Proper usage

Environment

Please avoid the following places:

- A place where this product may be damaged by strong impact or vibration.
- A place where corrosive gas or flammable gas and water, oil, dust exist.
- A place where magnetic and electrical noise occur.
- A place where high temperature and humidity are beyond rated specification.
- A place where there are strong alkalis and acids.
- A place where there are direct rays of sun.

Noise

- 1) We test 2kV, Pulse width 1μs against Impulse voltage between power terminals and 1kV, Pulse width 1μs at noise simulator against external noise voltage.

Please install MP condenser (0.1~1μF) or Oil condenser between power terminals when over Impulse noise voltage occurs.

- 2) When testing dielectric voltage and insulation resistance of the control panel with this unit installed.

- Please isolate this unit from the circuit of control panel.

- Please make all terminals of this unit short-circuited.

(It prevents the damage of inner circuit.)